

mimSAFE

www.mimsafe.se

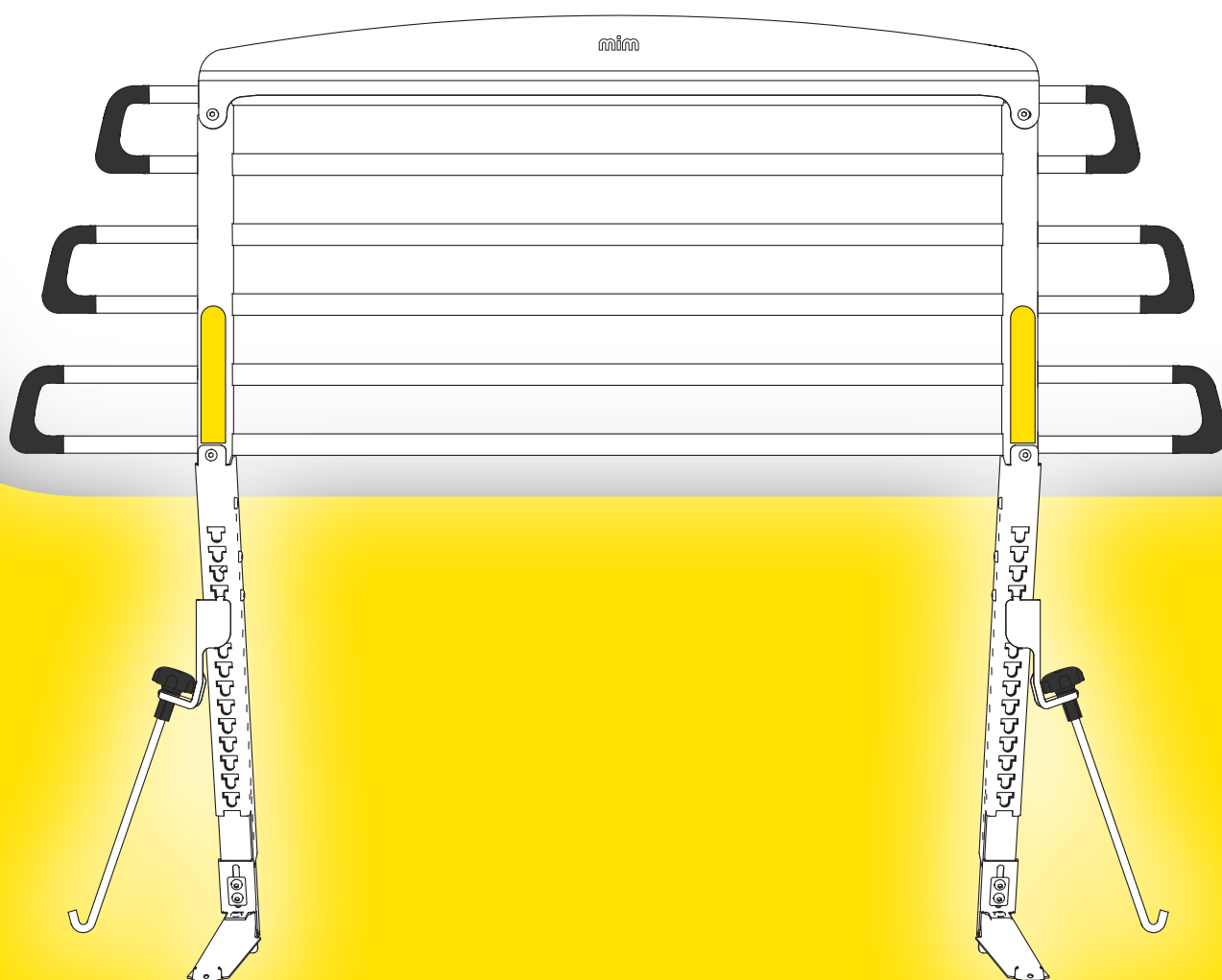

ASSEMBLY INSTRUCTIONS

VARIOBARRIER

large

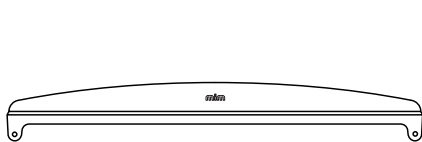
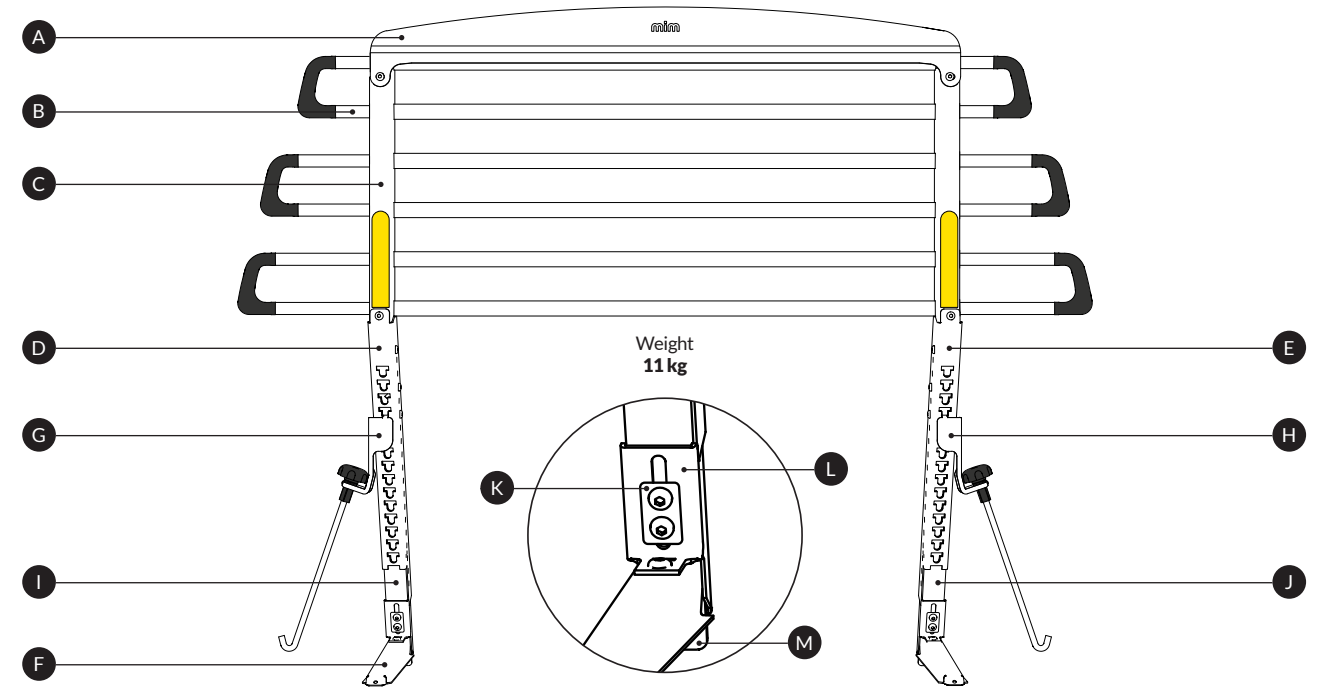

A F525
Part no 1x

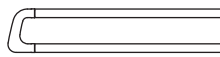

B F521
Part no 6x

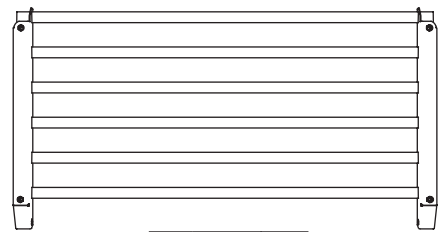

C FS510
Part no 1x

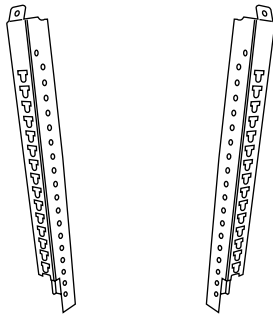

D F515L
Part no 1x

E F515R
Part no 1x



F F523
Part no 2x







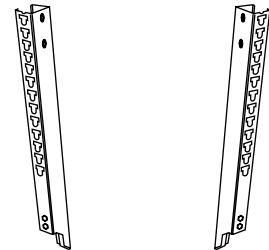







G F526L
Part no 1x

H F526R
Part no 1x

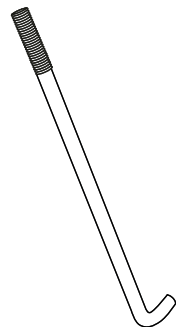

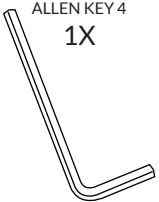

I F511L
Part no 1x

J F511R
Part no 1x

M-10700 6X  OPTIONAL	F529 2X  K	F527 2X  L	F528 2X  M	M-460641AY 12X  rubber end caps	M-460641AL 12X  plastic end caps	M-M37202_2004 2X 
M-SM6X14AI 18X 	ALLEN KEY 4 1X 	M-10322 1X 	M-10683 2X 	M-460641K 2X 	M-460641I 2X 	

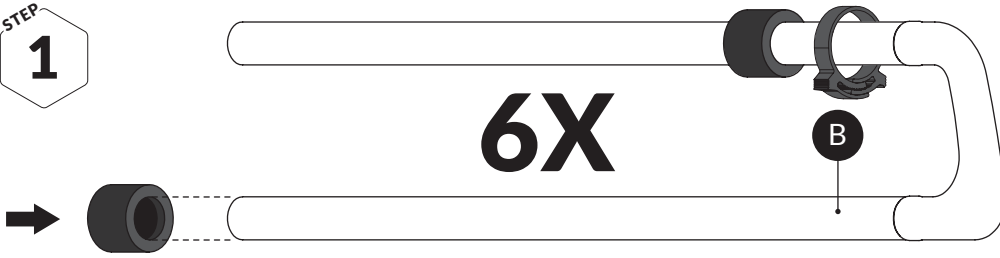
STEP
1



M-10700 6X  OPTIONAL	M-460641AY 12X  rubber end caps
--	--

STEP
2

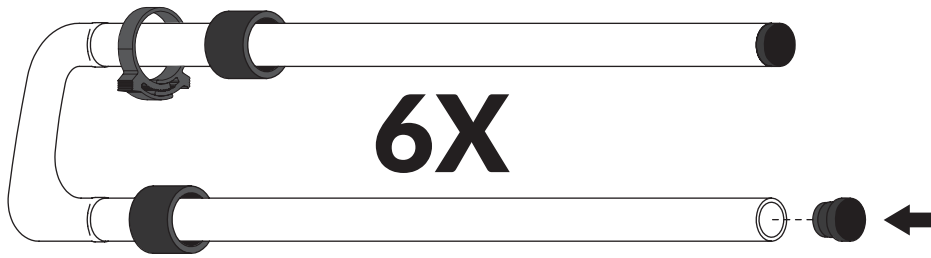

M-460641AL 12X  plastic end caps

STEP
3

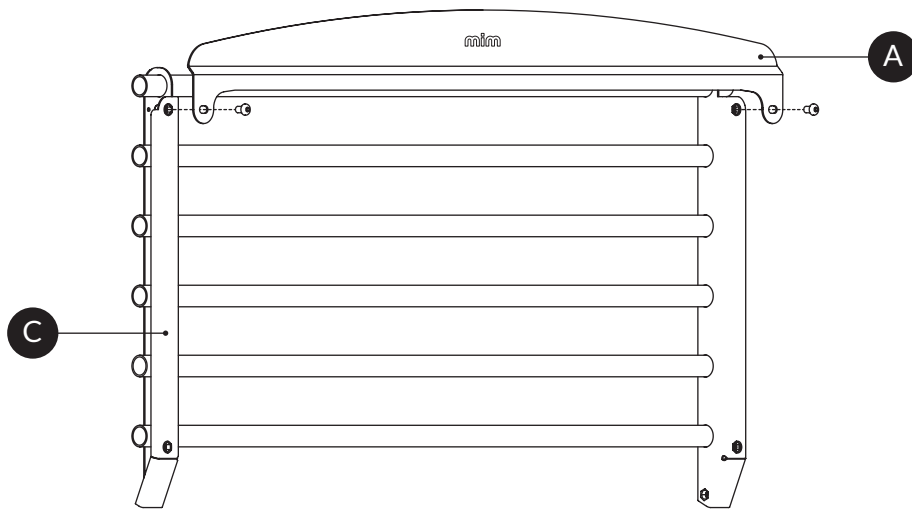

M-SM6X14AI 2X 
--

STEP
4

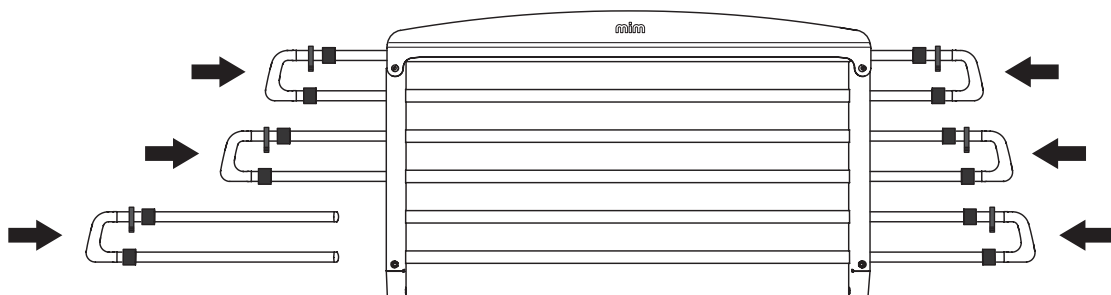

STEP
5

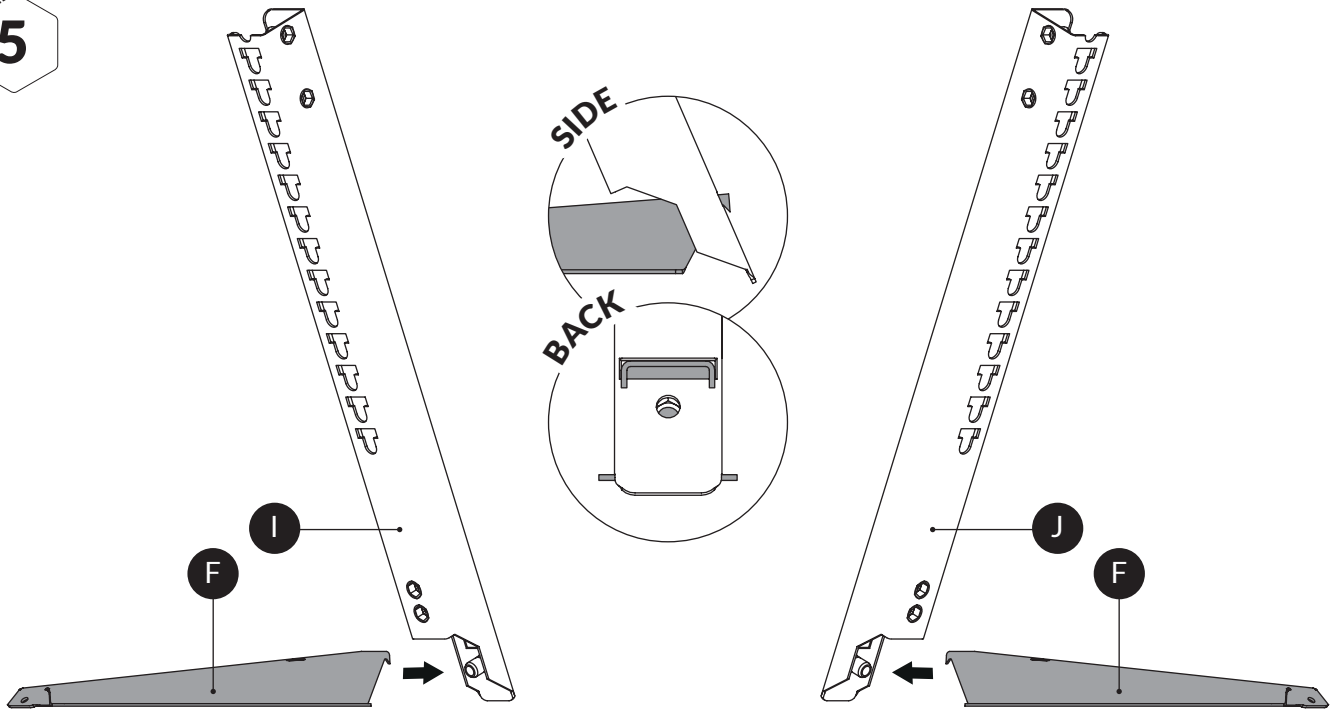

STEP
6

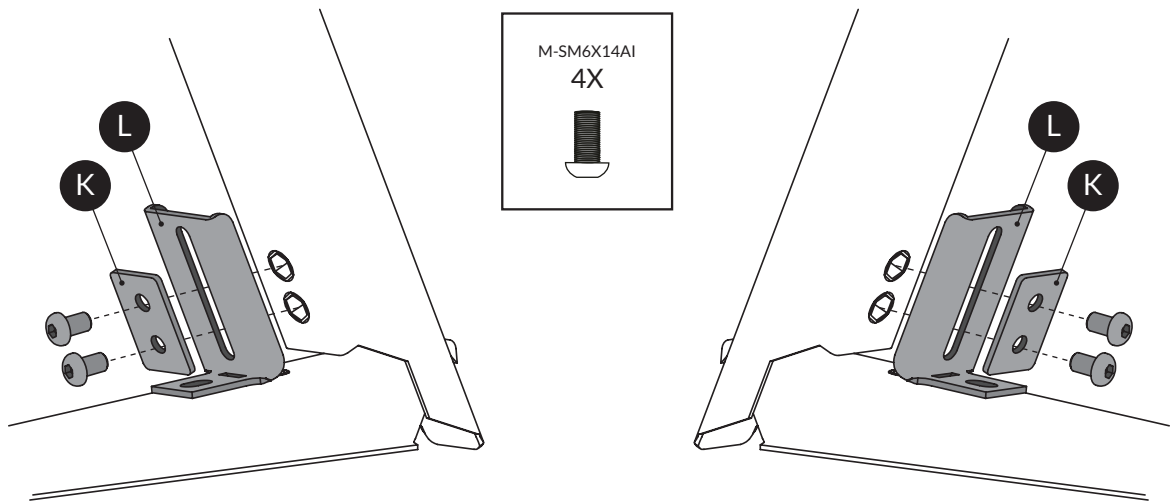

STEP
7

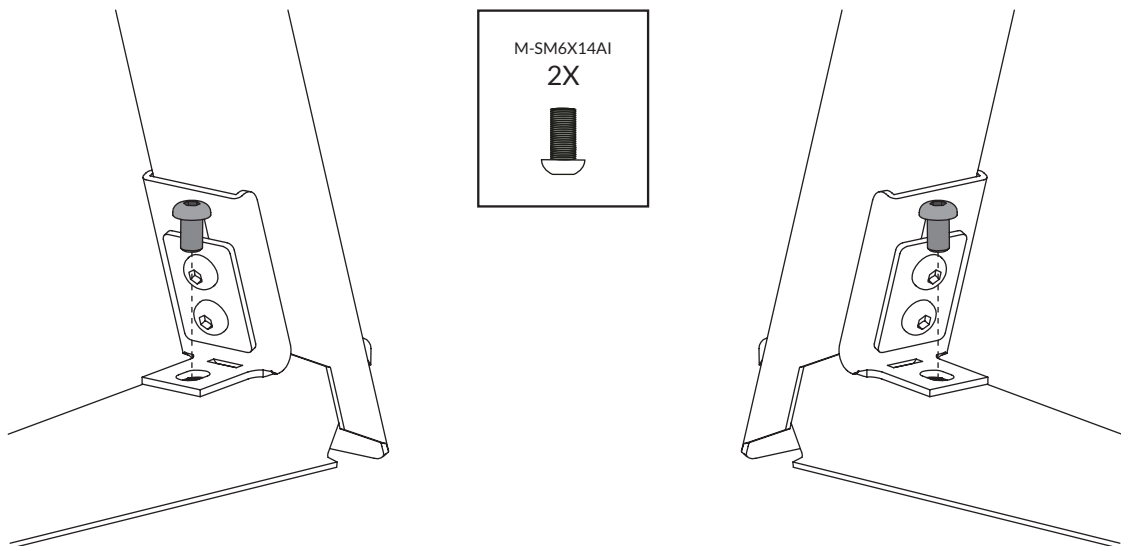

STEP
8

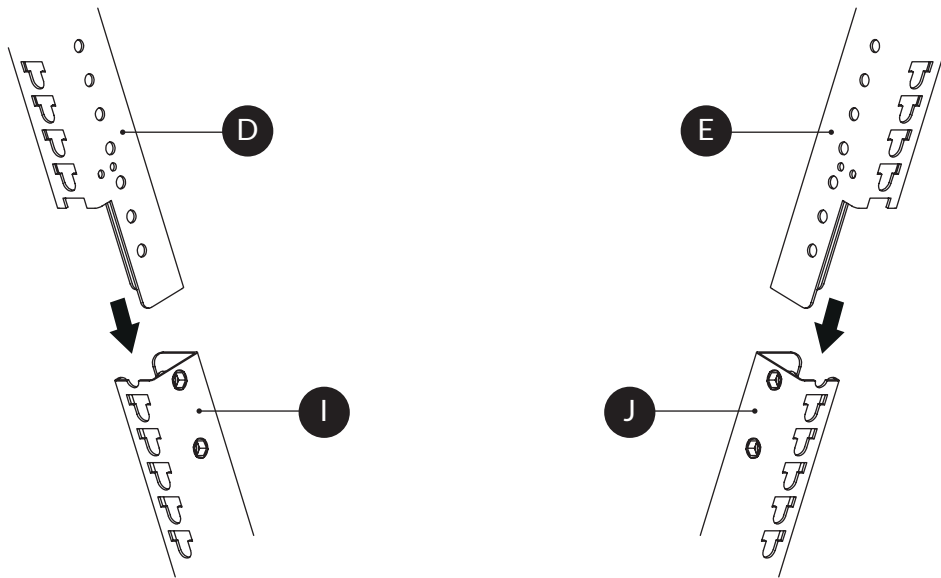

STEP
9

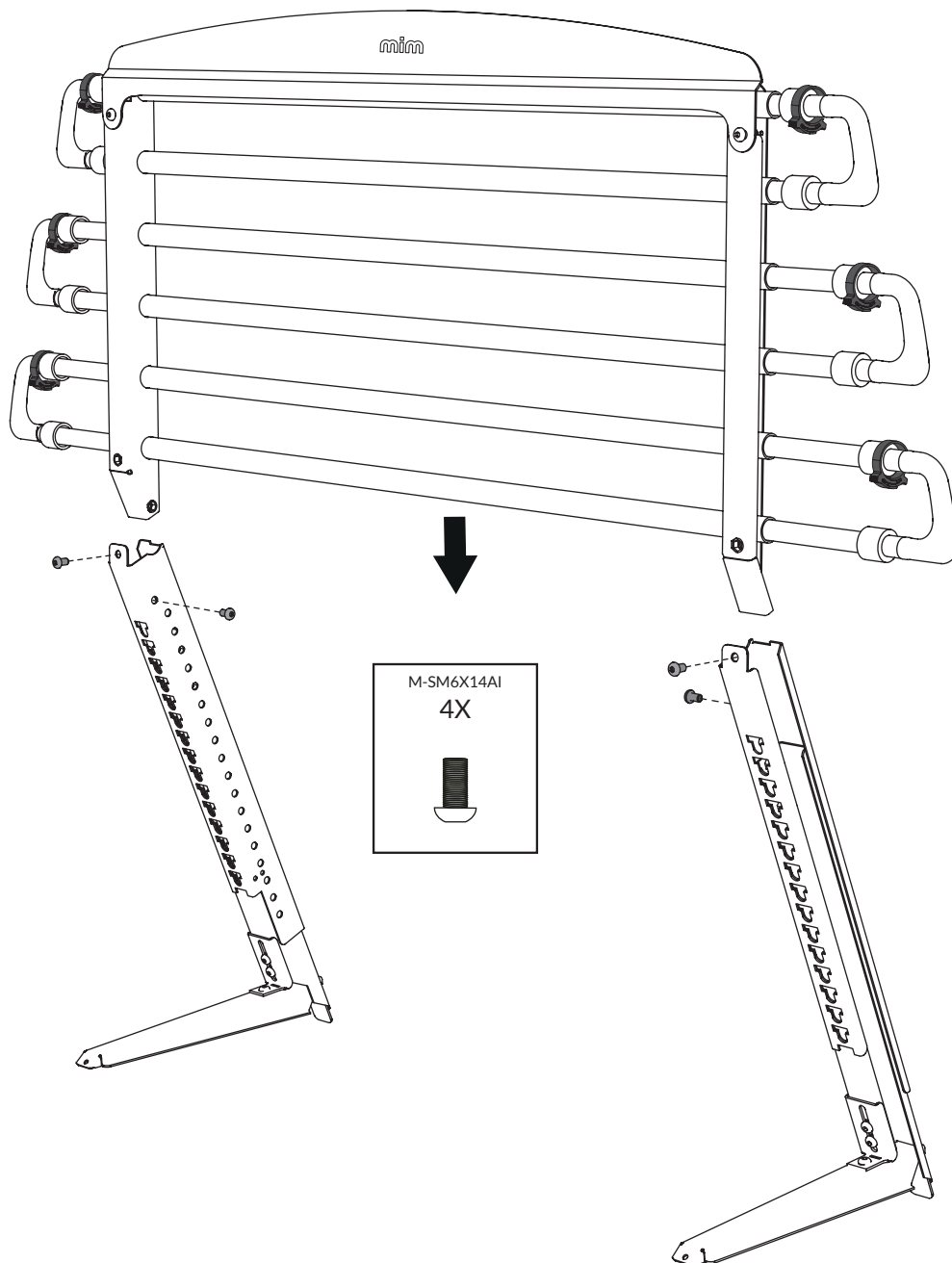

STEP
10

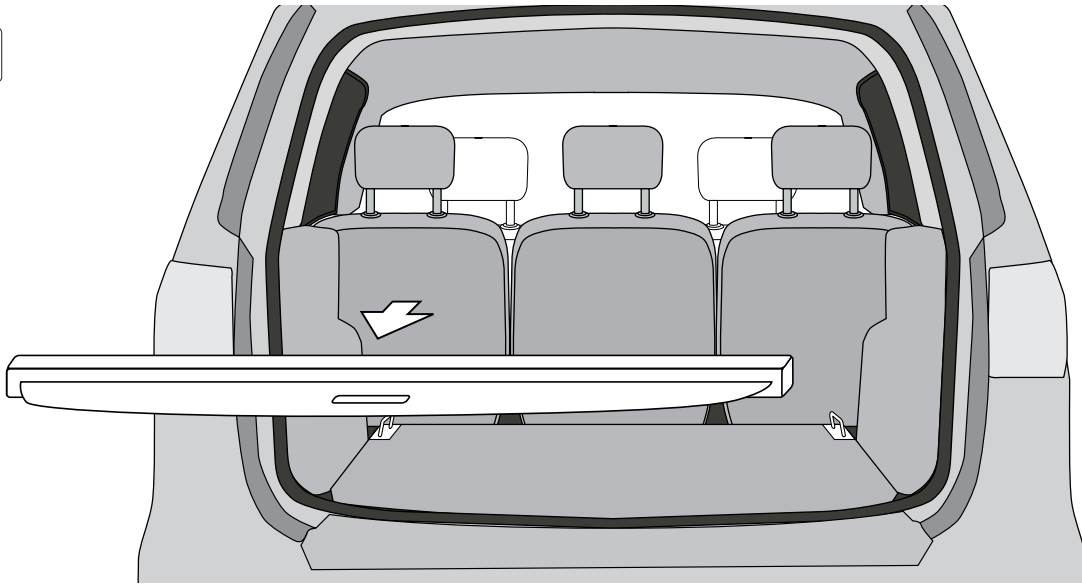

STEP
11

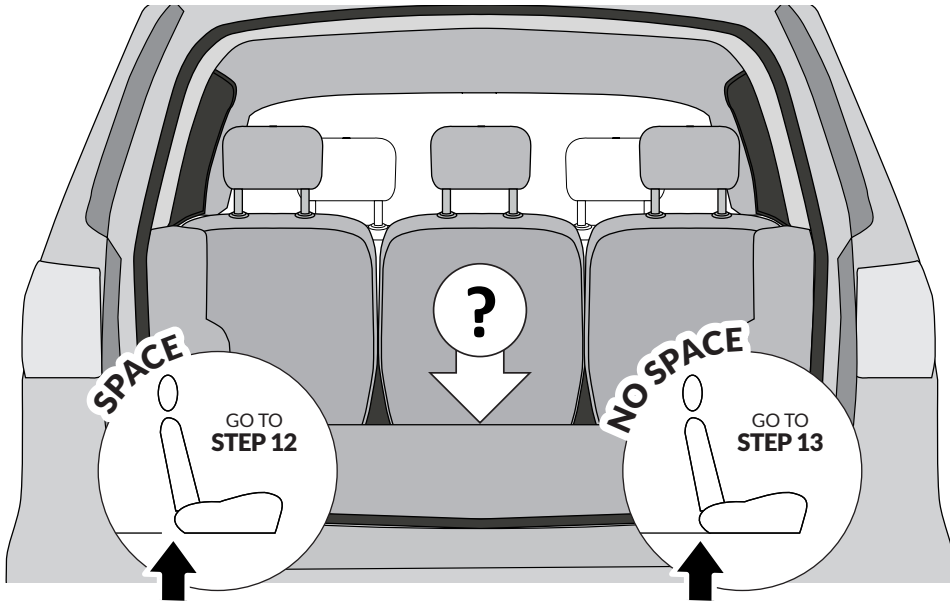

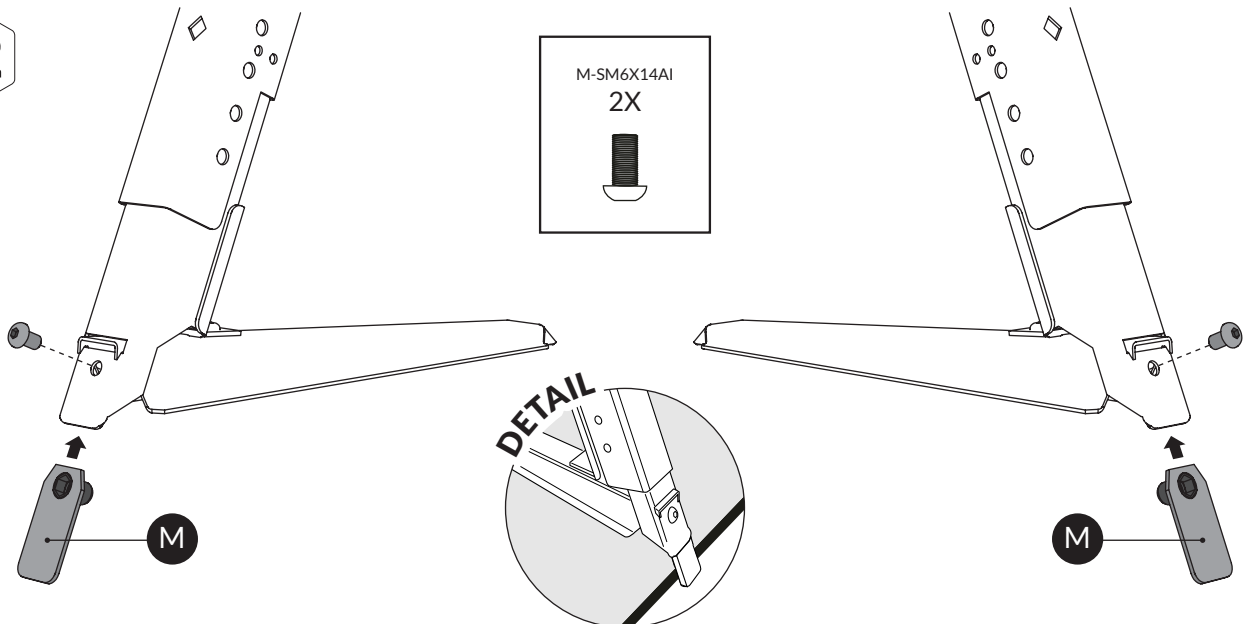

STEP
12

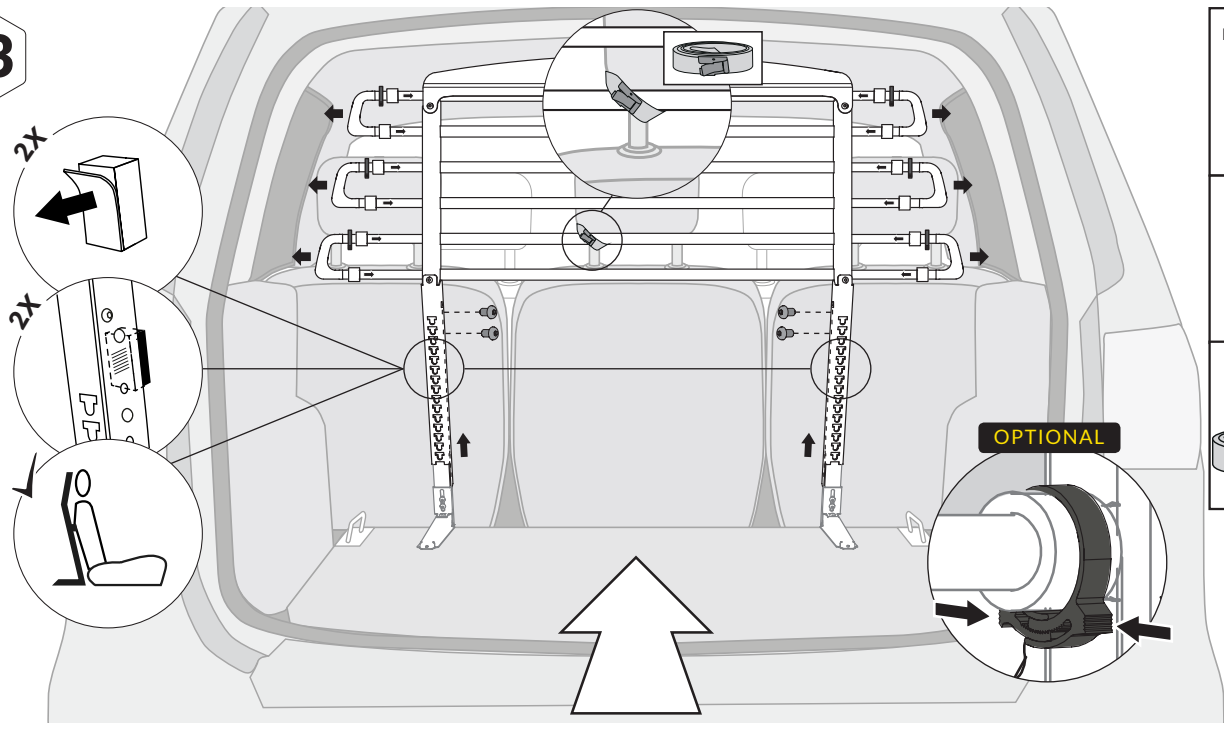

STEP
13



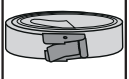

- M-SM6X14AI
4X

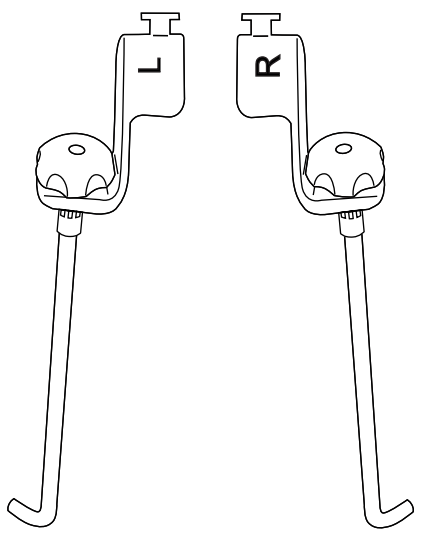
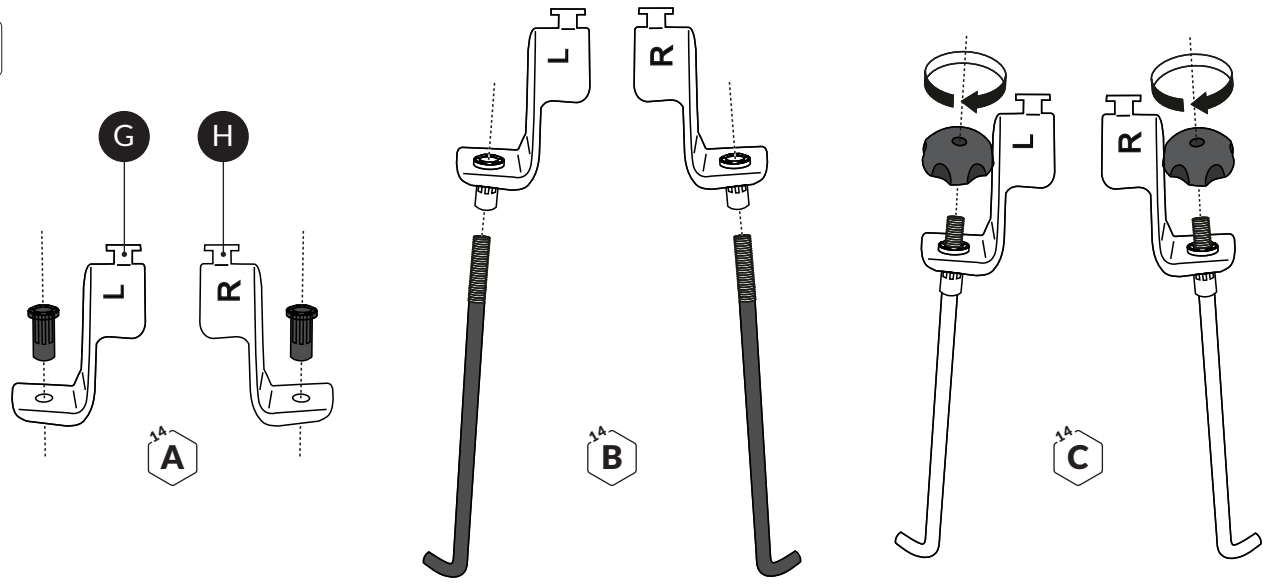
- M-10683
2X

- M-10322
1X

STEP
14

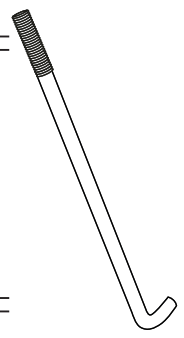

NO TOOLS IN THIS STEP
USE HANDS ONLY



- | | |
|--|--|
| M-460641K
2X
 | M-M37202_2004
2X
 |
| M-460641I
2X
 | |

STEP
15



STEP
16



USE HANDS ONLY
TIGHTEN THE WHEELS AGAIN
FEEL THE WHEEL SNAPPING

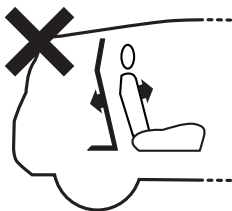
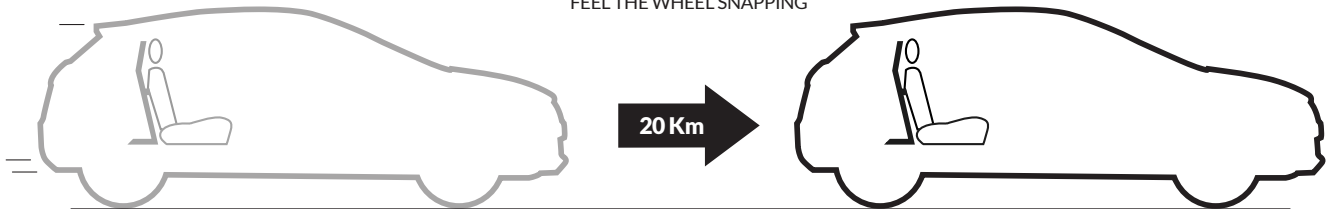

VarioBarrier must
ALWAYS BE PLACED
against the back seat

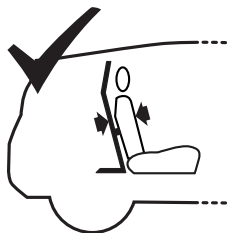

WARNING

VarioBarrier is
NOT SUITABLE FOR
outdoor use

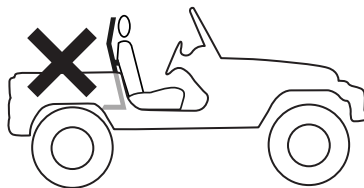

Wipe with a
DAMP CLOTH
with soap

